

# TTV 1500 / TTV 2500

**EN**

**OPERATING MANUAL**  
CONVEYING FAN





**Table of contents**

Notes regarding the operating manual ..... 01  
 Safety ..... 02  
 Information about the device ..... 03  
 Storage ..... 03  
 Start-up ..... 04  
 Operation ..... 04  
 Errors and faults ..... 04  
 Maintenance ..... 04  
 Disposal ..... 05  
 Technical annex ..... 05

**Notes regarding the operating manual**

**Symbols**

 **Warning of electrical voltage!**  
 This symbol indicates dangers to the life and health of persons due to electrical voltage.

 **Warning!**  
 This signal word indicates a hazard with an average risk level which, if not avoided, can result in serious injury or death.

 **Caution!**  
 This signal word indicates a hazard with a low risk level which, if not avoided, can result in minor or moderate injury.

**Note**  
 This signal word indicates important information (e.g. material damage), but does not indicate hazards.

 **Info**  
 Information marked with this symbol helps you to carry out your tasks quickly and safely.

 **Observe the manual**  
 Information marked with this symbol indicates that the operating manual must be observed.

 **Wear hearing protection!**  
 Indicates the activities during which hearing protection is to be worn.

The current version of the operating manual can be found at:



TTV 1500



<http://hub.trotec.com/?id=39417>

TTV 2500



<http://hub.trotec.com/?id=39418>

**Legal notice**

This release replaces all previous versions. No part of this publication may be reproduced without written permission from Trotec GmbH & Co. KG. The same applies for electronically processing, duplicating or spreading the publication. Subject to technical changes. All rights reserved. Trademarks are used without guarantee that they may be used freely and primarily following the spelling of the manufacturer. Product names are registered.

Changes to construction in the interests of constant improvements to the product, as well as changes to the shape and colour are reserved.

The scope of delivery may vary from product images. This document was created with all due care. Trotec GmbH & Co. KG accepts no liability whatsoever for possible mistakes or omissions. © Trotec GmbH & Co. KG

## Warranty and liability

The device complies with the fundamental health and safety requirements of the applicable EU regulations and was tested at the factory for perfect functionality multiple times.

However, if faults in the functionality occur and cannot be remedied with the measures in the Errors and faults chapter, please get in touch with your dealer or distributor.

When manufacturer's instructions or legal regulations have not been followed, or after unauthorised changes to the device are made, the manufacturer is not responsible for the resulting damages. Changes to the device or unauthorised replacement of individual parts can drastically impact the electrical safety of this product and leads to the forfeit of the warranty. Liability does not extend to damages to people or property caused by the device being used other than as described in the instructions in this operating manual.

Subject to changes to technical design and model changes as part of constant development and product improvement without prior notice.

No liability is accepted for damages resulting from improper use. In such a case, any warranty claims will be voided also.

## Safety

**Read this manual carefully before starting or using the device. Always store the manual in the immediate vicinity of the device or its site of use.**



### Warning!

**Improper handling can lead to injuries due to parts being whirled up.**

- Do not use the device in potentially explosive rooms.
- Do not use the device in aggressive atmosphere.
- Set the device up in an upright and stable position.
- Let the device dry out after a wet clean. Do not operate it when wet.
- Do not use the device with wet or damp hands.
- Do not expose the device to directly squirting water.
- Never insert any objects or limbs into the device.
- Do not cover or transport the device during operation.
- Do not sit on the device.
- This appliance is not a toy! Keep away from children and animals. Do not leave the device unattended during operation.
- Check accessories and connection parts for possible damage prior to every use of the device. Do not use any defective devices or device parts.
- Ensure that all electric cables outside of the device are protected from damage (e.g. caused by animals). Never use the device if the cable or power connection is damaged!
- The electrical connection must correspond to the specifications in the Technical data chapter.

- Insert the mains plug into a properly secured mains socket.
- Observe the technical data when selecting extensions to the power cable. Completely unroll the extension cable. Avoid electrical overload.
- Hold onto the mains plug while pulling the power cable out of the mains socket.
- Switch the device off and disconnect the power cable from the mains socket when the device is not in use.
- Do not under any circumstances use the device if you detect damages on the plug or cables. Defective power cables pose a serious health risk.
- Observe the operating conditions (see chapter Technical data).
- Remove the mains plug from the mains socket before carrying out maintenance, care or repair work on the device.
- Make sure that the air inlet and outlet are not obstructed.
- Make sure that there are no loose items located in the immediate surroundings of air inlet and air outlet.
- Improper installation can lead to a fire, electric shock or severe personal injury.

## Intended use

The conveying fan TTV 1500 / TTV 2500 may be used for aeration, deaeration, air circulation, dust collection or air transport whilst adhering to the technical data and the safety instructions.

The device is designed for aeration and deaeration tasks, for the generation of a high air exchange rate even in shafts and ducts and over long distances.

## Improper use

The conveying fan TTV 1500 / TTV 2500 is not suited for installation in fluids or on flooded or boggy grounds. Any unauthorised changes, modifications or alterations to the device are forbidden.

## Personnel qualifications

People who use this device must:

- be aware of the dangers that occur when using conveying fans.
- have read and understood the operating manual, especially the Safety chapter.

**Personal protective equipment**



**Wear hearing protection!**

Wear hearing protection when spending a longer period of time in the vicinity of the device.

**Residual risks**



**Warning of electrical voltage!**

Work on the electrical components must only be carried out by an authorised specialist company!



**Warning of electrical voltage!**

Before any work on the device, remove the mains plug from the mains socket!



**Warning of strong air current!**

Risk of injury from parts being whirled up. Before switching the device on, make sure that there are no loose parts located near air inlet or outlet!



**Warning of loose parts being drawn in!**

Keep a minimum distance of 3 m from the device on the suction side!



**Warning!**

Do not leave the packaging lying around. Children may use it as a dangerous toy.

**Behaviour in the event of an emergency**

1. Press the On/Off switch to switch off the device immediately.
2. Remove persons from the danger area.
3. Disconnect the device from the electric circuit.
4. Do not reconnect a defective device to the mains.

**Information about the device**

The conveying fan TTV 1500 / TTV 2500 was designed for a high air volume flow.

The high air volume flow and a variety of configuration options enable its flexible application ranging from humidity regulation to the transport of fresh air or exhaust air over longer distances.

The device is equipped with bilateral hose connectors allowing to connect, for instance, an air transport hose to the air inlet and a dust bag to the air outlet.

This makes the conveying fan an ideal transport fan for far-off connected air conditioning or heating applications.

It thus allows to increase the conveying distance of warm or cold air.

When the device is not in use, the power cable can be wound around the hose connection.

**Device depiction**

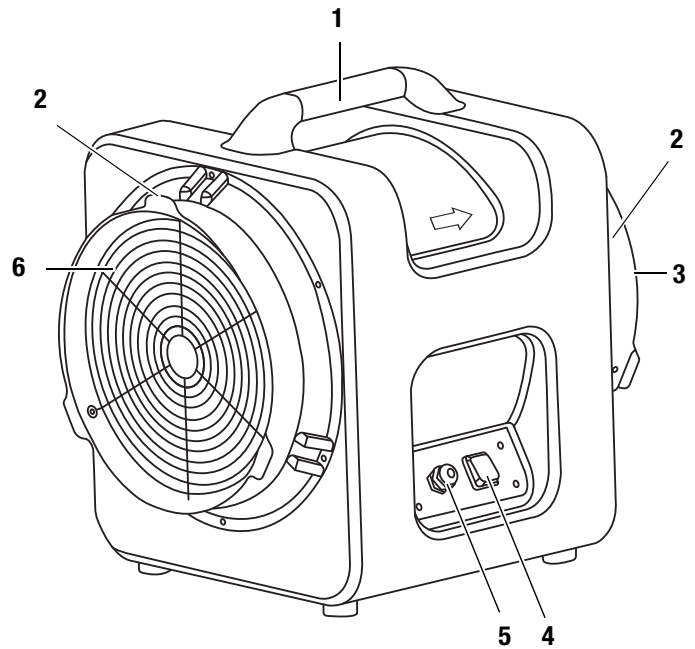

No.	Designation
1	Transport handle
2	Connector for air hose (optional)
3	Air outlet
4	On/Off switch
5	Power cable with Schuko plug CEE 7/7
6	Air inlet

**Scope of delivery**

- Device
- Manual

**Storage**

When the device is not being used, observe the following storage conditions:

- in dry surroundings,
- protected from dust and direct sunlight,
- with a plastic cover to protect it from invasive dust, if necessary.

## Start-up

1. Take the device out of the cardboard box and remove the plastic packaging.
2. Unwind the power cable.
3. Set the device up in an upright and stable position. Observe a minimum distance of 50 cm to walls and other objects.
4. Assemble the device according to the desired area of application along with other devices or accessories.
5. Connect the hoses or dust bags as follows:
  - Pull the air hose/dust bag (7) completely over the connector.
  - Fasten the air hose/dust bag with a tension belt (8).

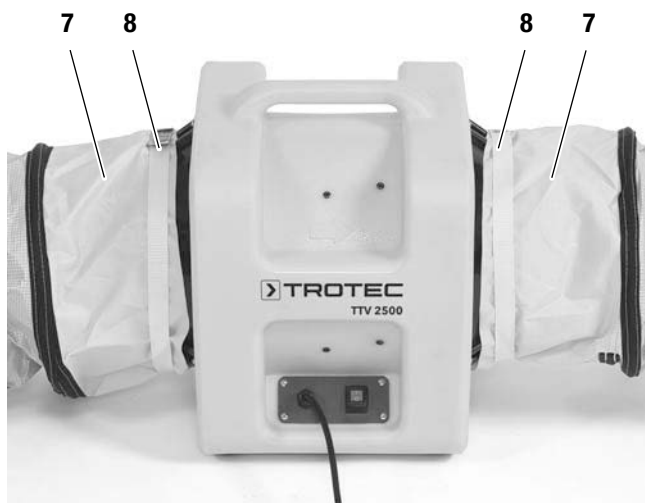

6. Plug the mains plug of the power cable into a properly fused socket.
  - The fan is now ready for operation.

## Operation

### Switching the device on

- Use the On/Off switch (4) to switch the device on.

### Shutdown



#### Warning of electrical voltage!

Do not touch the mains plug with wet or damp hands!

1. Switch off the device.
2. Remove the mains plug from the mains socket.
3. Clean the device according to the Maintenance chapter.
4. Store the device according to the Storage chapter.

## Errors and faults

The device has been checked for proper functioning several times during production. If malfunctions occur nonetheless, check the device according to the following list.

### The fan is not running:

- Check whether the unit is switched on.
- Check the power supply.
- Check the power cable and mains plug for defects.

### The fan operates only for a short time, then switches off automatically:

- Check whether the protective grid is blocked and clean it if required.
- The motor bearing or cable connections are defective. If so, contact your dealer.

### Your device still does not operate correctly after these checks?

- Bring the device to a specialist company or to Trotec for repairs.

## Maintenance

### Activities required before starting maintenance

- Before any work, remove the mains plug!



**Maintenance tasks which require the housing to be opened must only be carried out by Trotec.**



- Always pull the mains plug before starting any care or maintenance work.
- Regularly check the housing for its perfect condition or for defects.
- Always be mindful of atypical sounds and consult a specialist dealer if in doubt.
- Keep the fan clean.
- You can use a compressor to remove particles, lint, dust and dirt from the motor, fan wheel and protective grid. Do not in any event use a high-pressure cleaner to clean the fan.
- Maintenance and repair work may only be carried out by Trotec.

## Disposal



In the European Union, electronic equipment must not be treated as domestic waste, but must be disposed of professionally in accordance with Directive 2002/96/EC of the European Parliament and of the Council of 27 January 2003 on waste electrical and electronic equipment (WEEE). At the end of its life, please dispose of this device according to the valid legal requirements.

## Technical annex

### Technical data

Parameter	Value	
Model	TTV 1500	TTV 2500
Article number	1.510.000.006	1.510.000.007
Amount of air	1050 m <sup>3</sup> /h	2200 m <sup>3</sup> /h
Air pressure	225 Pa	300 Pa
Voltage	230 V / 50 Hz	230 V / 50 Hz
Power input	0.17 kW	0.44 kW
Fusing	10 A	10 A
Transport medium temperature	Max. 45 °C	Max. 45 °C
Hose connector	∅ 200 mm	∅ 300 mm
Hose length	Max. 15 m	Max. 38 m
Noise level (distance 3 m)	71 dB(A)	79 dB(A)
Dimensions (length x width x height)	348 x 285 x 324 (mm)	470 x 390 x 460 (mm)
Weight	8 kg	17 kg

Accessories	TTV 1500	TTV 2500
	Art. no.	Art. no.
Air transport hose Tronect SP-T, length 7.6 m	6.100.001.200	6.100.001.205
Dust bag, length 3 m	7.160.000.108	7.160.000.109
Universal tension belt	6.100.001.995	6.100.001.995
Replacement hose connectors	7.310.000.007	7.310.000.008

## Declaration of conformity (Translation of the Original)



### EC Declaration of Conformity in accordance with EC Machinery Directive 2006/42/EC

**TROTEC® GmbH & Co. KG**

Grebbener Straße 7  
D-52525 Heinsberg

herewith declares that due to their design and construction, and in the version introduced by us, the following machines conform with the relevant fundamental requirements of the listed EC directives.

#### Important note:

In case of improper use, installation, maintenance etc. or unauthorized changes of the factory-supplied device version, this declaration loses its legal validity.

<b>Device version:</b>	Conveying fan	
<b>Series:</b>	<b>TTV 1500 / TTV 2500</b>	
<b>Year of manufacture:</b>	as of 2016	
<b>Applicable regulations:</b>	2006/42/EC 2014/35/EU 2014/30/EU	Machinery Directive Low Voltage Directive EMC Directive
<b>Applied harmonised standards:</b>	IEC 60335-1:2002 + A1: 2004 + A2: 2006 IEC 60335-2-80: 2002 + A1: 2004 + A2: 2008 EN 55014-1:2006+A1:2009+A2:2011 EN 61000-3-2:2006+A1:2009+A2:2009 EN 61000-3-3:2013 EN 55014-2:1997+A1:2001+A2:2008 EN 61000-4-2:2009, EN 61000-4-4:2012 EN 61000-4-5:2006, EN 61000-4-6:2014 EN 61000-4-11:2004	

Producer and authorised representative of the technical documentation:  
Trotec GmbH & Co. KG · Grebbener Straße 7 · D-52525 Heinsberg  
Phone: +49 2452 962-400 · Fax: +49 2452 962-200 · E-mail: info@trotec.com



Heinsberg, 8th June 2016

Managing Director: Detlef von der Lieck

**Trotec GmbH & Co. KG**

Grebener Str. 7  
D-52525 Heinsberg

☎ +49 2452 962-400

☎ +49 2452 962-200

[info@trotec.com](mailto:info@trotec.com)

[www.trotec.com](http://www.trotec.com)